



MASURIA®



...FROM THE LAND OF THE THOUSAND LAKES





The wind in the sails, the stars shining on the water, priceless mornings wrapped by fogs of Masurian lakes, sunsets over the endless horizon of the sea... Sailing has always been my passion and it is reflected in every aspect of my life.

In design, I follow the principle of balance, but I don't perceive it purely mathematically - rather as equal proportions of dreams, passion, and craftsmanship. This is my "Golden Ratio". And that's how the MASURIA brand was created.

Each project I create is a huge challenge for me - an individual attempt to combine functionality with a shape that triggers emotional responses. Attention to detail and appropriate selection of materials allow me to create products that are reliable, comfortable and maintain consistent aesthetics. MASURIA is a tool to create a unique atmosphere, from culinary variations and flavours born in fire, to the romantic evenings in the glow of the flames of our fireplaces.

MASURIA has been created for people with that certain little twinkle in the eye; a little bit of inventiveness will make every day and evening a special one.

Sebastian Pawłowski





MASURIA STOVE nexo was awarded SPECIAL MENTION at the GERMAN DESIGN AWARD 2021

narie	nexo
juno	stilo

Table of Contents

MASURIA narie	5
KITCHEN narie	8
SOFA narie	25
ARMCHAIR narie	27
COFFEE TABLE narie	29
FIREPLACE narie	30
MASURIA nexo	35
STOVE nexo	39
SHELF nexo	53
LAMP nexo	57
MASURIA juno	65
Juno 600	69
Juno 800	73
LAMP juno	83
MASURIA stilo	93
Stilo 600	97
Stilo 800	98
ACCESSORIES	103

MASURIA narie

Perfection filled with passion and fascination for Masurian nature. **MASURIA narie** is the result of years of observing the surroundings, during which the concept of luxury furniture was created, filling the picturesque space outside the four walls of a building. Barbecues, fireplaces and furniture are not only practical and functional supplements to the garden, patio or terrace, but also landscape elements, perfectly matching the idyllic atmosphere, inspired by the land of a thousand lakes.

We combine the uniqueness of natural wood with the austerity of steel to develop simple, minimalist forms of furniture that create the perfect environment for cooking, relaxation, and the unique atmosphere that accompanies it.





Synergistic combination of warmth provided by wood and rawness of steel



MASURIA®



narie KITCHEN



Wood

The **kitchen** is a place full of flavours and aromas, it is here where wonderful dishes are composed to savour them together with our loved ones.

We decided to intensify the effect of warmth by using exotic wood to create countertops and decorative elements of the **kitchen**. The natural grain of the exotic wood uniquely blends with the colours of the kitchen, while providing high comfort of use.

Selected wood showing uncompromisingly high quality is also used in the production of sea yachts, meaning it retains its properties even in the most difficult conditions and under heavy loads. Furthermore, we have protected it with natural MASURIA oils, which will undoubtedly prolong its durability and emphasise its pattern more significantly.

Steel

The upper parts of the **kitchen** work zone in particular are exposed to very high temperatures. Because of that, we have made them out of durable, heat-resistant stainless steel. This allows the entire surface to be fully utilised for safe and comfortable cooking. The raw steel harmonises beautifully with the warmth of the wood. The entire structure creates a very harmonious and complementary visual composition.

The **kitchen** is available in two versions, as it was created from two different types of steel. Corten steel **kitchen** has the unique ability to change colour to “rusted”, the result of the natural patina formation process due to weather conditions. “Rusty” patina is not only an interesting colour, but also demonstrates protective properties.



Elegant minimalism and noble simplicity, decorated with natural wood design, and enhanced with a steel finish.





Flavours and scents inspired by the changing scenery of the environment are provided by the **narie** mobile **KITCHEN**. It is equipped with wheels, allowing it to be moved freely.



MASURIA®

A natural wood-fire **kitchen** is perfect for outdoor dining and those looking for an unusual cooking experience.

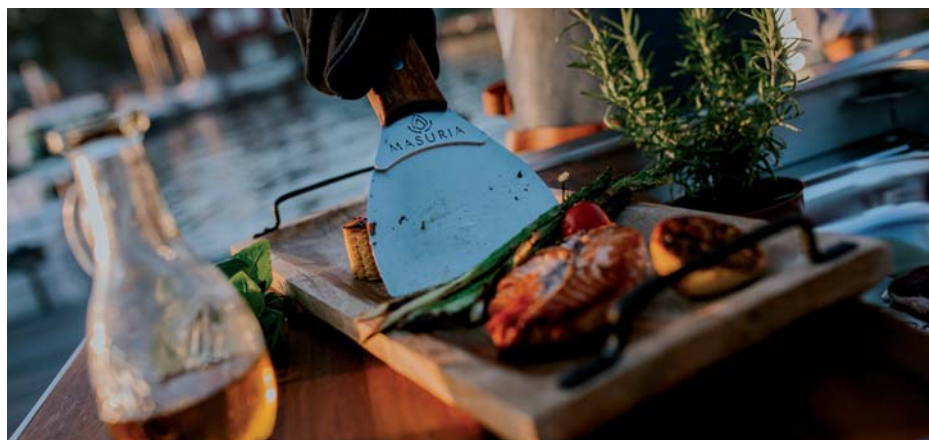



Water system

Everything you need within reach. The **narie KITCHEN** is equipped with a water system consisting of: electric water heater, water and drain connection, mobile water and drain quick connect.

Cooking containers

Durable stainless steel GN1/1 containers with a depth of 40 mm provide a high degree of convenience.

The GN container system is a standard developed for the convenience and comfort of cooks, and is used worldwide. This solution makes it easy to stock our kitchen with food prepared earlier.





Power supply cable socket, water supply and water discharge.

Blower adjustment

Cook pleasantly and safely in outdoor conditions.

The **kitchen** has an adjustable blower. The system includes an electric blower so you can easily control the fire.





Extension

A practical two-piece extension, made of stainless steel and additionally equipped with a grill grate. The shape and size accommodates both most cooking utensils and easy refilling of wood.

Hearth

The hearth in kitchen combines comfort and functionality.

Thanks to the solutions used in our kitchen, you will quickly fire up the kitchen and reach the desired temperature. But, what is also important, after the feast is over, when the dust settles and the kitchen cools down, you will be able to clean it and prepare it for the next meeting with friends.





Decorative lighting

The natural light wonderfully emphasises the filigree shape of the kitchen. It is a perfect combination with the LED light panels hidden on either side of the countertop. This decorative accessory provides the entire composition with more charm, draws attention and enhances the experience.



Countertops

Kitchen countertops with changing function and purpose. They fold out to increase work space as well as comfort. There is a place for a GN type gastronomic container and a functional sink hidden under the countertops.

The tops are made of glued exotic wood with increased resistance to weather conditions.



Fronts

The exotic wood perfectly emphasises the outdoor character of the **narie KITCHEN**.

The front and back of the furniture is made of high-quality waterproof plywood with natural exotic wood veneer. The wood is characterised by a strong and well-defined grain, which harmonises beautifully with the raw patina of steel in the corten version and the depth of black in the black version.

Space for wood

Wood is not only the decoration of the mobile **kitchen**, but also its mandatory equipment, necessary to light a fire to cook a meal. Chopped wood arranged on a shaped shelf creates a striking decoration to match the atmosphere of the feast and the surroundings.





Cover

The **narie KITCHEN** will last longer thanks to a cover made of weather-resistant material.

It is perfectly adapted to the shape and size of the **kitchen**, securing it tightly on all sides.

Additional information

Weight 210 kg

Dimensions 160 × 74 × 120 cm

Colours



Corten



Black

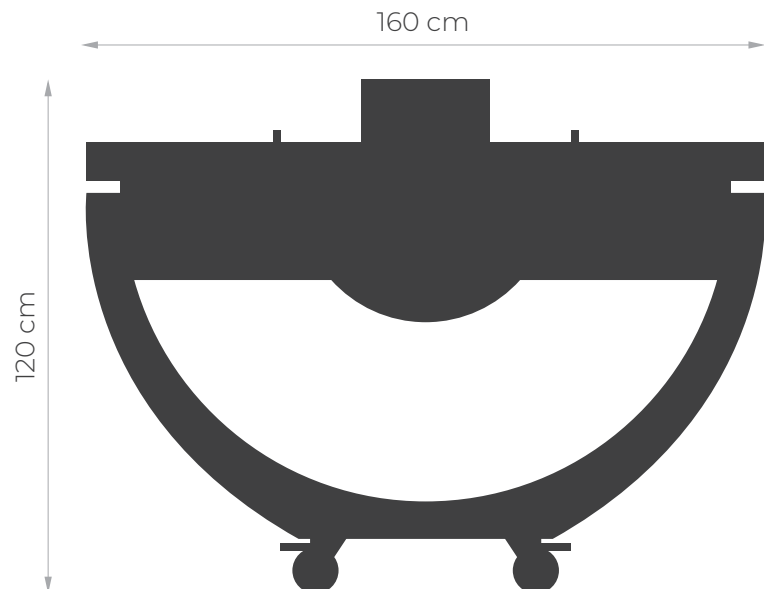



Unlimited possibilities for preparing, cooking and eating.



An extremely practical yet unique piece of furniture which houses a handy wood reservoir. The entirety creates a unique picture painted with the colours of nature, where you can feel like a Master Chef.

Thanks to the properties of MASURIA brand **kitchens**, you can feel and see the high-quality meals that you prepare with all your senses. The tastings will create an exceptional and unique atmosphere for you and your guests. Everyone will feel special in such an atmosphere.



The **narie KITCHEN** is a perfect solution for people who appreciate cooking and preparing meals together with their household members or guests.

Thanks to its dimensions and functionality, the **narie KITCHEN** will also prove useful during culinary training or live cooking shows. What sets it apart is its versatility and - despite its size - its compactness and the possibility of organizing the workspace according to the cook's preferences.





Outstanding design and craftsmanship



Sofa, armchair and coffee table form a complete concept of garden furniture, representing the highest level of aesthetics and exquisite comfort of use.

MASURIA®



narie GARDEN FURNITURE



Exotic wood

A true breath of nature filling the luxurious furniture, inscribed in a green scenery of vegetation. The furniture is made of exotic wood characterised by increased resistance to weather conditions and mechanical damage, such as deformation and abrasion of stainless steel and corten, depending on the version.

Exotic wood used in offshore yachts for deck finishing has been used by us as the main construction material, thus providing the furniture with durability and strength.

Steel casing

The glossy pieces are made of stainless steel. Not only do they decorate the furniture, but most importantly provide stability. They emphasise solidity and perfection of workmanship, ensuring long-term use, even in case of intensive exploitation and frequent exposure to adverse weather conditions.

The corten steel version creates a new look for the furniture, and the patina colour works wonderfully with the sunny brown of the wood.

Comfortable seats

The specific aesthetics are accompanied by comfort of use. The **sofa** and **armchair** have a mattress with the right firmness to suit the method and frequency of furniture use. The mattress is upholstered with a high quality waterproof fabric available in two colours. The product does not change or lose its colour or properties due to exposure to sunlight.

narie SOFA



The **sofa** looks impressive from all sides and perfectly harmonises with the environment.

This furniture is a combination of high quality exotic wood and stainless steel or corten steel for added weather resistance.

Additional information

Weight 72 kg
 Dimensions 162 x 70 x 70 cm

Colours



Corten



Black

Upholstery colours



Beige



Ice



162 cm

70 cm





The steel rails forming the backrest are also a decorative element. Underneath the seat, there is a place for wood to fill in the free furniture space.



The upholstery of the product is available in two colours: beige and ice. Colour samples are indicative only and should not be construed as an exact colour match for the product listed.



narie ARMCHAIR

The **armchair** complements the sofa and together with it, they form a complete lounge set for the garden, terrace or patio, which harmonises perfectly with its surroundings.

The chair's contoured armrests provide even more comfort. This furniture is a combination of high quality exotic wood and stainless steel or corten steel for added weather resistance.

The steel rails forming the backrest are also a decorative element.

The upholstery of the product is available in two colours: beige and ice.



Additional information

Weight 57 kg
Dimensions 107 × 70 × 70 cm

Colours



Corten



Black

Upholstery colours



Beige



Ice



107 cm



70 cm



narie COFFEE TABLE



The **narie COFFEE TABLE** is a perfect complement to the entire MASURIA furniture collection.

Long evenings with the flames glowing, with your friends over a cup of your favourite coffee or a glass of wine, will create the perfect mood.

This furniture is a combination of high quality exotic wood and stainless steel or corten steel.

The wooden top and construction supported by metal legs provide the table with lightness. The free space under the countertop can be a practical solution for storing wood.

Additional information

Weight 45 kg
Dimensions \perp 98 × \perp 63 × \perp 45 cm

Colours



Corten



Black



98 cm



45 cm

narie FIRE PIT



The **FIRE PIT** from the MASURIA narie collection will ensure wonderful evenings spent with your loved ones.

The simple and functional design of the **FIRE PIT** will fit into any space.

The designed wood storage area provides easy access to keep the wood warm for a long evening.

Additional information

Weight 52 kg

Dimensions 98 × 63 × 45 cm

Colours



Corten



Black

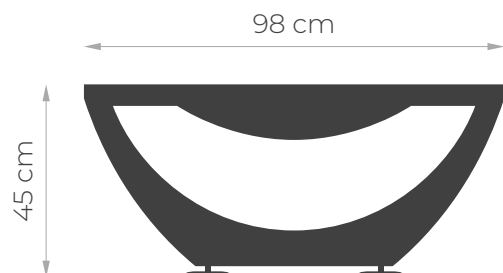

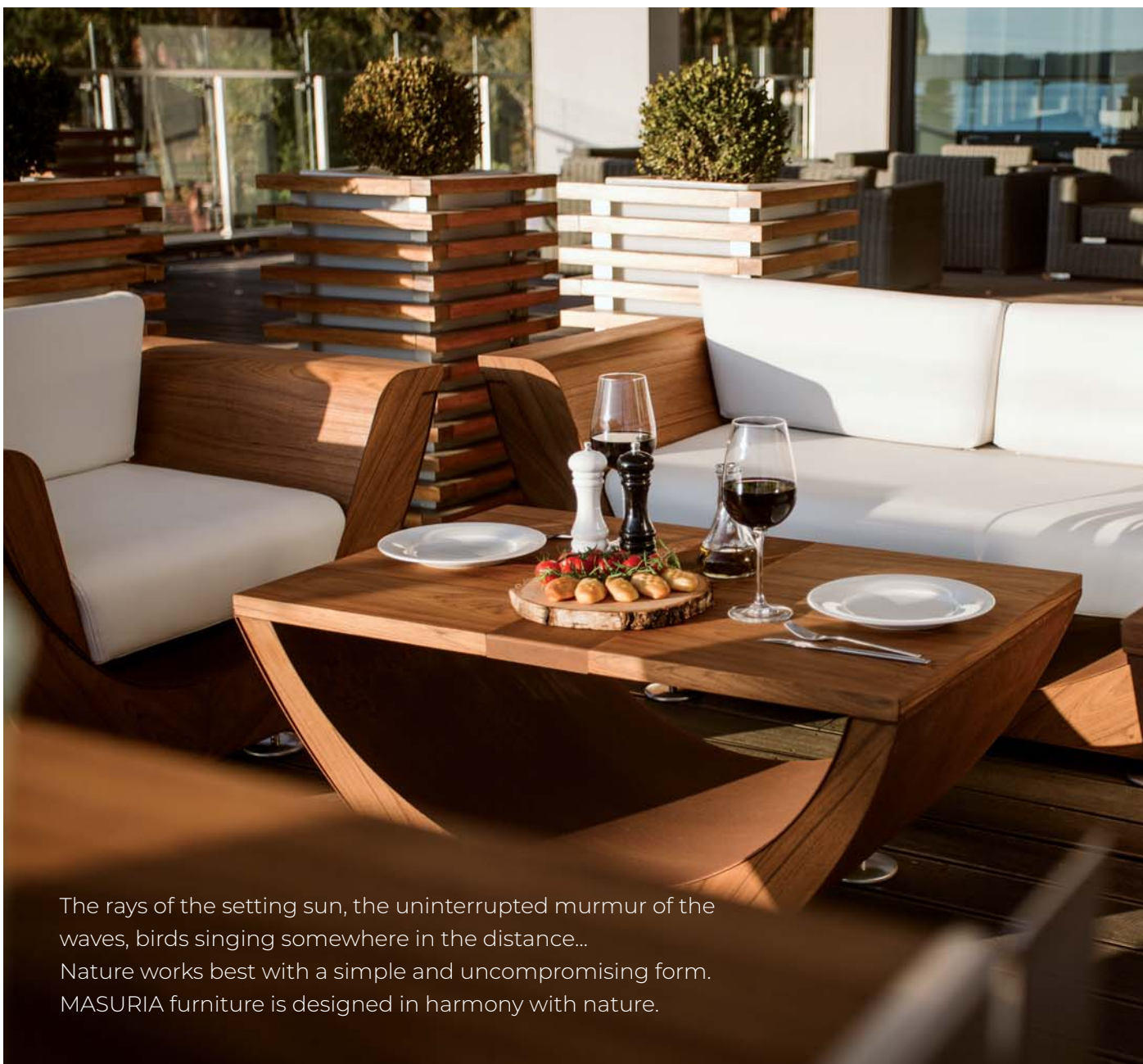

The rays of the setting sun, the uninterrupted murmur of the waves, birds singing somewhere in the distance... Nature works best with a simple and uncompromising form. MASURIA furniture is designed in harmony with nature.





The timeless beauty of natural wood, the exotic character of a selected species with increased resistance and the perfectly crafted shapes of MASURIA garden furniture - this is a realised concept for designer comfort, where handcrafted, artisanal work can be noticed in each and every furniture surface. They bring visual delight with their impeccable silhouette, yet are comfortable and extremely durable, created as dictated by nature.

A lakeside terrace, a picturesque garden in the middle of the woods, or golden coastal beaches. MASURIA was designed and developed with our natural surroundings in mind, harmoniously blending with them.

MASURIA furniture collection - is a comfortable and stylish set that introduces an atmosphere of blissful relaxation or carefree vacation.

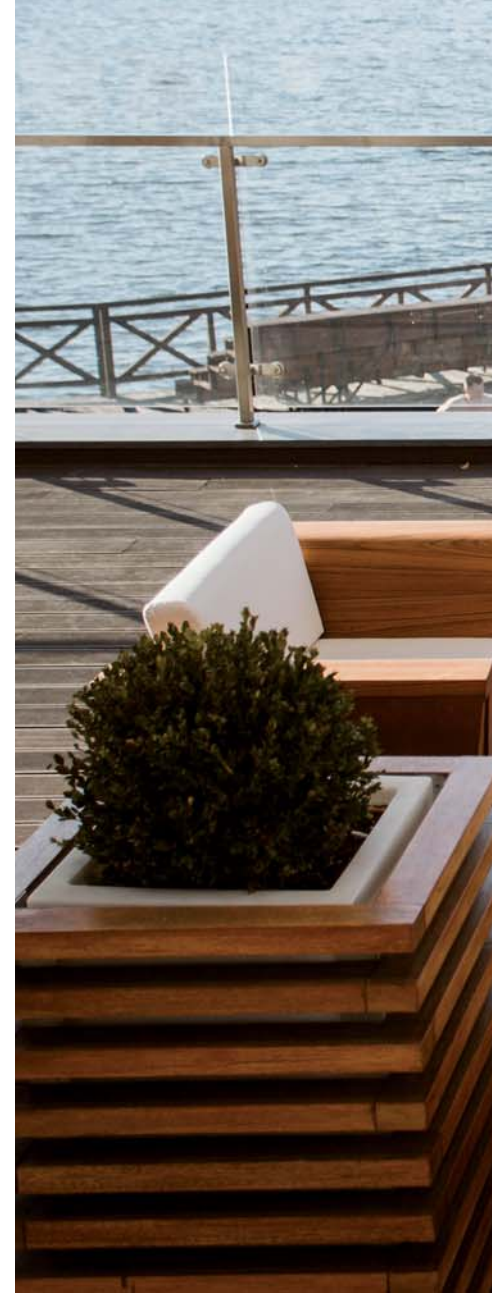



MASURIA kitchen accessories are the essence of good taste and style, which also plays a very important role in the kitchen.

MASURIA nexo

The **MASURIA nexo** collection is a combination of uncompromising design, referring to the design classics, together with exceptional usability.

Whether you are a pizza or barbecue lover, or just want to spend time in inspiring settings...

nexo will fill your space with beauty and simplicity.





Minimalism of form, more fire and authentic flavours

Functional products with a traditional look fit into virtually any outdoor space.



MASURIA®



nexo STOVE, nexo SHELF, nexo LAMP



Retro design, exotic wood and stainless steel

The collection perfectly utilises the potential of fire and wood. Tradition dressed in innovation. Even more opportunities to create an atmospheric mood outdoors. Even more excuses to cook in a scenic natural setting.

Modernised classic, referring to the retro design, was created for enthusiasts of individual and functional solutions.

Equipped with a steel grilling/cooking plate, the **stove** allows you to heat, cook and bake in the traditional way outdoors, including pizza and bread.

The modular, multi-faceted and modern wood-burning **stove** combines two elements - tradition and functionality.

The nexo collection is available in two colour versions: corten and black painted stainless steel. The corten version is made of corten steel, which is characterised by a rusty colour that changes when the steel is exposed to weather conditions.

The rusty colour is a natural patina that not only adds beauty to the furniture, but also protects its surface from corrosion.

Exotic wood with increased resistance to external factors and exploitation interacts with steel, creating a surprisingly natural design.

nexo STOVE



The **nexo STOVE**, together with the chimney and pizza module, form a complete set, creating unlimited culinary possibilities, as well as a warm and pleasant atmosphere.



nexo STOVE



MASURIA®



A **stove** made of stainless steel offers endless possibilities. It can be used as a typical heating fireplace to provide warmth on cool evenings. In addition, it is equipped with a separate element - a practical pizza module designed for preparing pastries in the traditional manner - in wood-fired ovens.





Plancha

The **nexo STOVE** is equipped with a traditional food preparation plancha.

The absence of direct contact with the fire allows you to prepare healthy meals.

Pizza module

The practical pizza module is designed for baking in the traditional way - in wood-fired ovens. It provides you with the option of baking pizzas and breads on a chamotte stone.

Thanks to a special thermometer, you can easily control the temperature inside the oven, which is so important during baking.





Hearth

It is made of stainless steel or corten steel in a rusty patina colour, and features a removable grate and an ash pan with air circulation.

In order to increase the comfort and convenience of use, the skids have been reinforced, allowing you to use the hearth also independently, outside the fireplace.

Glass

The high quality glass in the **stove** door is heat resistant, meaning it can withstand extremely high temperatures of up to 800 degrees Celsius.

This solution allows you to enjoy the view of the fire, while maintaining safety of use.





Chimney

Made of stainless steel, the chimney serves more than just a utilitarian role. Its specifically designed height makes cooking extremely comfortable, and it also acts as an additional heat radiator on cool evenings.

Housing

It comes in two versions. In stainless steel painted black with heat resistant paint with a matte finish, and in corten steel.

The legs are made of durable and solid exotic wood, which adds elegance to the entire structure.





Fireplace hearth

The ergonomically-shaped stainless steel hearth with a 4 mm thick grate is a precisely thought-out and useful form that can also be used outside the fireplace as an independent garden hearth.

Chamotte stone

Pizza and bread baked on a chamotte stone gain a unique taste and aroma that cannot be reproduced in a home oven.





Thermometer

The clear and stylish thermometer allows you to precisely control the temperature inside the oven.

Additional information

Weight 78 kg
 Dimensions \perp 72 × \perp 55 × \perp 216 cm

Colours



Corten



Black

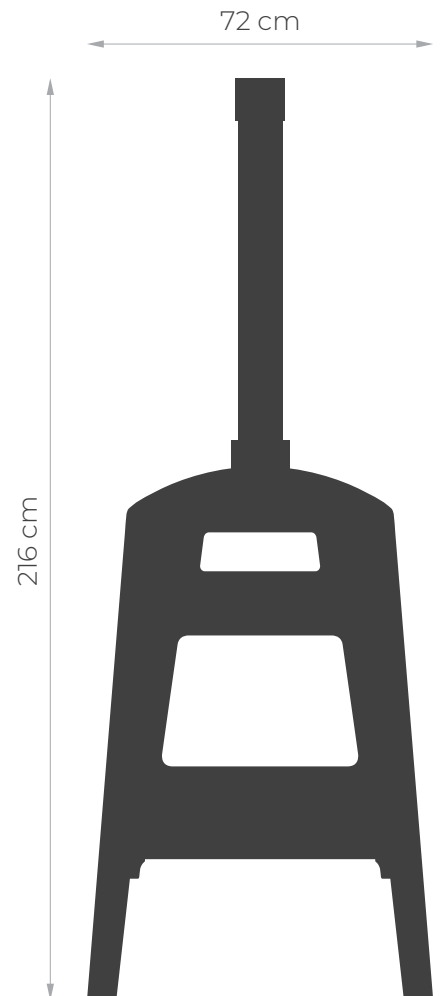



PERFORATED

TEMPERATURE GAUGE

MISHI



Nexo STOVE outside was designed for people who love the synergy of tradition and the latest technology. Only such a combination guarantees a unique atmosphere combined with safe relaxation in the glow of the firelight.



The MASURIA collection oven will provide extraordinary warmth and allow you to pursue your culinary passions. It will evoke the atmosphere of the Masurian lakes surrounded by forests.



The **nexo STOVE** will fill the space not only with a beautiful and calming glow from the flames, but also the warmth that will turn even a cold evening into a special moment. Its original style and atmosphere will transport you to the land of Masuria, where the hum of the forest merges with the lapping waves of lakes and singing birds.

The pizza module allows you to bake crispy bread, traditional pizza, pita, as well as meats and vegetables. Inside, there is a chamotte stone that keeps the temperature high and prevents food from burning.

Quick and easy firing makes the **stove** ready to use in just 20 minutes. Inside, there are the perfect conditions for cooking food while preserving all the flavours.

High temperatures, reaching up to 400 degrees Celsius, make the baking time noticeably shorter than with other methods.

The wood-fired oven constitutes a return to the roots and authentic flavours of traditional baking methods. This is how pizza is still baked today in traditional Italian restaurants hidden in picturesque and cosy tenement houses, and how bread is baked in Polish bakeries still cultivating artisan baking traditions.

The smell of burning wood in the air, permeated with the aromas of fresh dishes, is a wonderful way to enchant the senses of our guests even before the dishes are served.



The **stove** combines traditional heating and outdoor cooking solutions.



Authentic flavours and extraordinary experiences. Wood-burning oven.



Designed with great care and attention to detail and aesthetics, the wood-burning **stove** guarantees a high standard of use and the highest quality of healthy and fabulously tasty dishes in ecological settings.



nexo SHELF

Every chef, even the best one, needs a helper to pass the necessary utensils or prepare the ingredients. When inviting guests to have a feast together, it is difficult to imagine asking them to help in preparing showpiece dishes.

This is where the **nexo SHELF** comes in handy. Thanks to its carefully designed form, it does not take up too much space, but at the same time it is roomy enough to accommodate all the necessary ingredients and utensils.

The subtle design makes a perfect combination with the fireplace.





Corten version

Extremely light, made of wood and steel, aesthetic, unique and practical, the **nexo SHELF** is available in two versions: stainless steel painted black with a matte finish, and a corten steel version.



115 cm

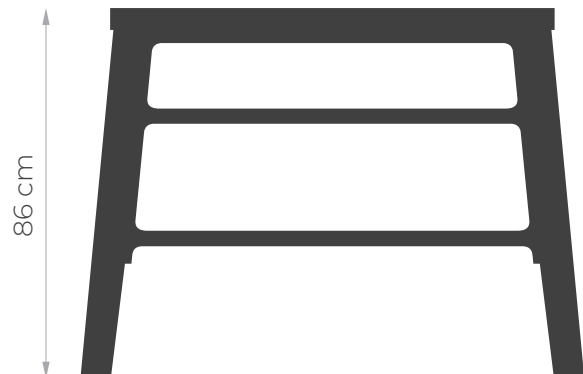

86 cm

Additional information

Weight 45 kg
 Dimensions \perp 115 × \perp 44 × \perp 86 cm

Colours



Corten



Black





The **SHELF** from the **nexo** collection not only perfectly complements the fireplace, providing additional space for plates, cutlery or wood, but can also function as an independent piece of furniture. Depending on the version, it is made of corten steel, or stainless steel and exotic wood.

Plus, it will fit perfectly into any space. Spacious shelves will satisfy everyone's requirements.



nexo LAMP



More fire and a moody atmosphere without smoke and the unpleasant smell. The eco-friendly biofuel **lamp** beautifully illuminates the darkness of the garden or terrace.

The minimalist design is emphasized by the steel housing.

The **lamp** is made of stainless steel stained black, or corten steel, with legs made of exotic wood.

A more functional alternative to candles - a more atmospheric light in your environment.





Extinguisher

Keep fire under control.

Although **nexo LAMPS** are designed in such a way as to be as safe as possible, caution is always in order.

That is why, among the accessories, you will find a steel extinguisher for safe fire extinguishing.

Ecological safety lamp

nexo LAMPS are ecological and safe for the environment. Thanks to the use of biofuel, the lamps illuminate the area with the glow of fire, and their unobtrusive and subtle design fits perfectly into the natural environment.





Additional information

Weight 16 kg
Dimensions 37 x 37 x 129 cm

Colours



Corten



Black





Ecological **lamps** created for the love of minimalism and subtle forms blend in with the environment, emphasising its natural beauty.

Slim shapes in muted colours close to nature not only brighten up the area, but also introduce an element of intimacy and homely warmth.



The lightweight form of the **nexo LAMP** makes it fit into almost any natural environment. Whether it is a backyard patio or lakeside location...



The **nexo LAMP** was inspired by our designer's love for everything connected with Masurian nature. The slimness of the shapes immediately remind one of forests that smell clean and fresh, with thousands of lakes hidden among them.

Thanks to the application of an ecological fuel burner, the **lamp** is in perfect harmony with pristine nature.





Ecological **nexo LAMPS** add a natural glow of fire to the environment, complementing it with an element of fairy-tale warmth.

Functionality, environmental friendliness and the form referring to natural shapes result in a **lamp** that fits into the timeless trend of living in harmony with nature.



The uncompromising and almost ascetic form of the **nexo LAMP** is an embodiment of the latest trends in design, referring to the classics. This modern and ecological **lamp** will highlight the original and unique style of your favourite space.

MASURIA juno

Like a lighthouse for navigating on the sea, it warms and illuminates its surroundings with the gentle glow of its flame and strong heat.





Warmth, atmosphere and taste

MASURIA®



Juno is a multifunctional product collection showing beautiful design and practical applications.

Juno 600, Juno 800, juno LAMP

Stable construction, mobile hearth

Juno is made of solid metal moulded into a shape that allows you to comfortably use all its functions. Its natural design is emphasised by the nautical rope covering the base.

With the addition of a hearth extension, you can not only warm up your surroundings, but also cook delicious meals the traditional way.

Juno hearths have excellent form, combined with attention to functionality and the use of wood to obtain the most human-friendly heat.

They come in two sizes for a perfect fit in your environment. Their structures are not only sturdy, but reflect practical design - easy to light, cook and maintain a fire at which you can also stay pleasantly warm.



Juno 600



Juno hearths include timeless marine design and exceptional functionality.



Grill extension

For meats and vegetables. Practical extensions made of high temperature resistant steel.

Once the fire is lit, the grill is ready to go.

Space for kitchen accessories

It is a practical place for storing kitchen utensils necessary for the preparation of baked dishes. It keeps them always within reach.

Made of stainless steel, it is easy to clean.





Adjustment of air access

By adjusting the air supply to the hearth, you can easily control the speed of wood burning and the temperature of the board.

Interior of the hearth

This aesthetically made, visually integrated hearth allows for quick and easy lighting of the fire necessary for cooking and warming the environment.

The hearth has a special container that can be easily removed and emptied. This keeps it clean, which is also important for its proper operation.



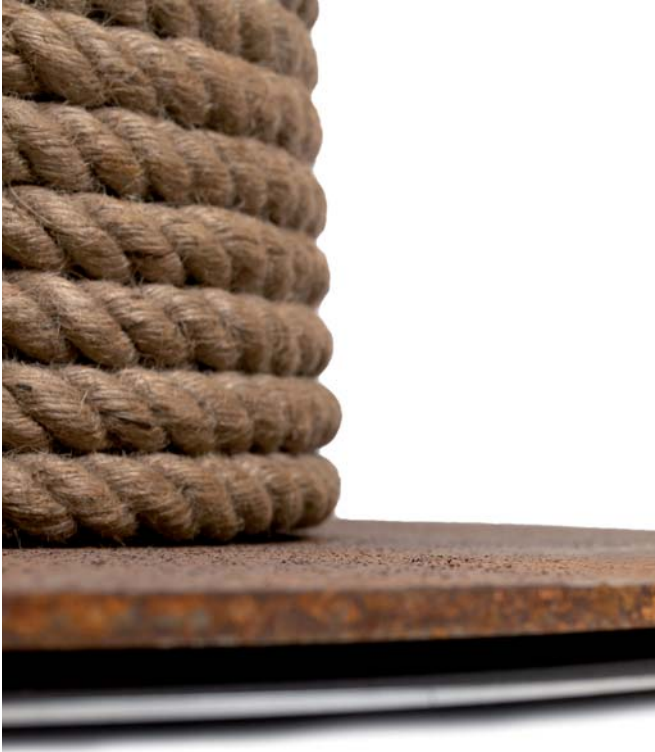

Base

Solid and stable, yet simple and light in form, the base is braided with natural jute rope.

The base ensures the stability of the hearth and emphasises our love of nature and ecology.

Additional information

Weight 61 kg

Dimensions \perp 59 × \perp 59 × \perp 98 cm

Colours



Corten



Black

Rope



Naturalna



Juno 800



Wind, water... **Juno**.

It is a fully professional tool that will meet the expectations of the most demanding user. Its size allows for comfortable work at large events and intimate live cooking shows.

Juno 800 will work well in restaurants, as well as at home.



Additional information

Weight 140 kg

Dimensions \perp 84 × \perp 84 × \perp 105 cm

Colours



Corten



Black

Rope



Naturalna

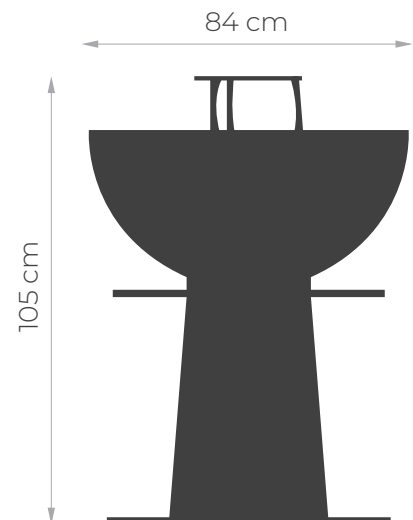



Hearth

The ergonomic shape of the hearth bowl and the special flange that supports the wood allow for precise heat transfer directly to the inner part of the profiled steel plate, quickly heating it. Thanks to the proprietary air circulation system, firing up is quick and comfortable - **Juno** is ready to go in less than 30 minutes. The heat accumulated in the board allows for instant thermal processing of food, while maintaining all the valuable qualities of the prepared dishes.

With its uniform plane, the board limits the access of harmful substances.

Juno 800 is equipped with a system that allows you to quickly prepare the product for reuse.

Stand for the grill

Comfort and cleanliness every day.

A stainless steel stand for grills and corten lamps will allow you to enjoy the unique design of our collection in every place, protecting the substrate against unwanted traces of patina.

Now you can put your favorite grill without fear, even on an oiled wooden floor.





Grill extension

For meats and vegetables. Practical extensions made of high temperature resistant steel.

Once the fire is lit, the grill is ready to go.





Juno 600 and **Juno 800** are inspired by the love of nature, highlighting its qualities. They fit into the natural landscape and provide unforgettable pleasant moments, as well as healthy and tasty meals eaten in nature. **Juno** hearths provide plenty of culinary experiences and the joy of preparing perfect meals.



MASURIA®

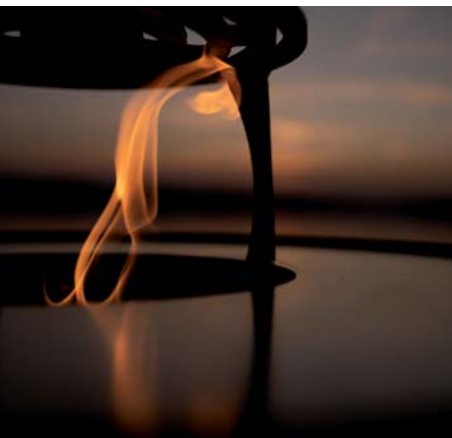

The prepared dishes have a unique taste and smell, enhanced by the aromas of nature. Thanks to our designer's proprietary solutions, meals cooked on **Juno** will be healthy and aromatic.





Meals prepared in nature have a unique taste, but they are also a challenge for any cook.

Thanks to the ease of use and safety of the **Juno** hearth, everyone can feel like a real chef and grill master. Nevertheless, **Juno** is more than just a culinary delight. The wood-burning hearth provides the warmth and glow of a fire, which introduces an unforgettable atmosphere.





juno LAMP



The **juno LAMP** not only provides the subtle glow of the flame, but also, thanks to its design gives a lot of warmth and a unique atmosphere. The use of a biofuel burner makes the lamp friendly to the environment and your surroundings.

Maintaining the marine design of the **juno LAMP** makes it fit perfectly into any natural landscape, adding not only warmth, but also a unique coastal atmosphere.

The **lamp** is made of top quality steel, heat resistant glass and stylish sailing rope.



Bioethanol

The **juno LAMP** was designed with attention to even the smallest detail.

The use of a biofuel burner allows you to enjoy the natural glow without having a negative impact on the environment.

Heat-resistant glass lampshade

A heat-resistant tube-shaped **lamp** cover made of clear glass guarantees extraordinary lighting effects while maintaining safety standards.



Air supply

The stainless steel burner cover of the **juno LAMP** provides a controlled air supply that keeps the flame glowing without interference.



Base

Wrapped in natural jute rope, the solid and durable base of the lamp provides it with stability and guarantees safety of use.

The use of nautical design additionally makes the entire construction light and unobtrusive.



Additional information

Weight 25 kg
Dimensions 46 × 46 × 136 cm

Colours



Corten



Black

Rope



Naturalna

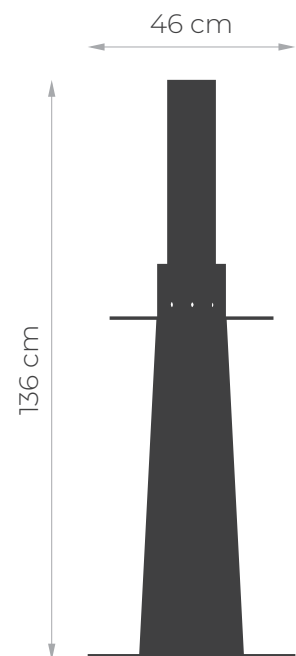

Water and fire are two theoretically mutually exclusive elements. We were able to combine the two. When designing **juno LAMP**, we wanted the themes of fire and water to permeate each other, creating a stylish combination that pleases the increasingly demanding eye, but also has a typically utilitarian function.

The **juno LAMP** combines the natural glow and warmth of fire, laced with subtlety and taste.



Water and forest are the natural habitat of the **juno LAMP**. Thanks to its slender and lightweight form, it perfectly blends in with the natural surroundings, emphasising its beauty and subtle character.



We know how important carefully designed details are in modern design. The **juno LAMP** was created to illuminate its surroundings with its glow.

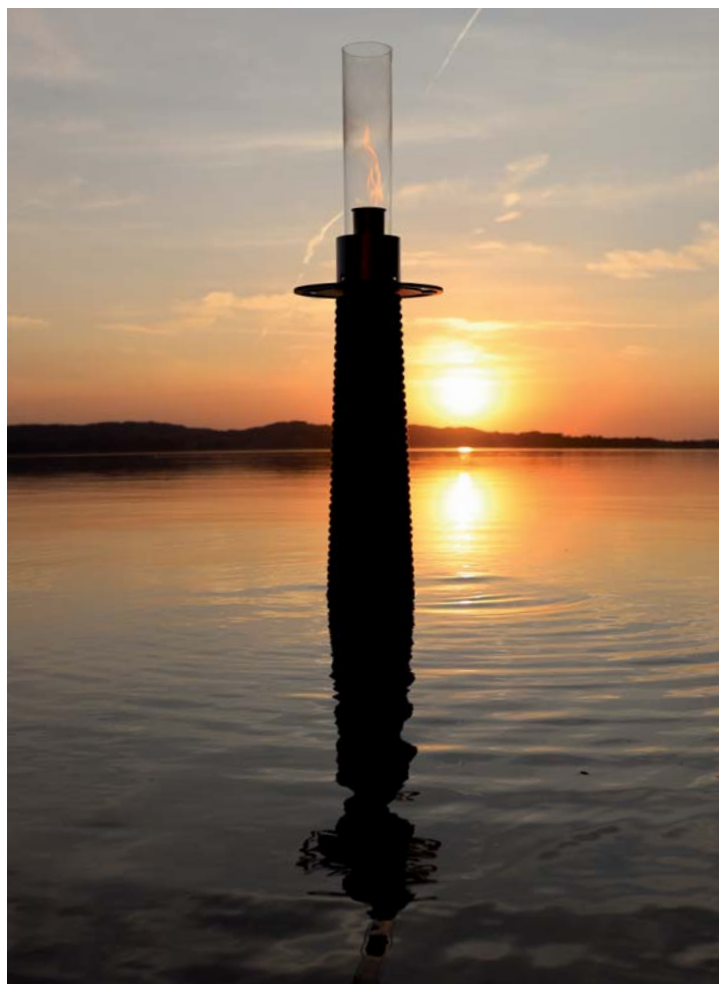

The use of a tall tube, made of heat-resistant glass and the burner allows you to enjoy a beautiful, naturally warm light even after sunset.







Timeless design.

Juno lamps, characterized by an absolutely maritime design, will fit not only in the coastal landscape. Thanks to their design, even modern or traditional terraces/patios and spaces will gain a unique atmosphere and seaside breeze.



MASURIA stilo

Timeless style and elegance enclosed in a simple and extremely usable form. This hearth with a dedicated place for wood will be the perfect addition to a large garden, where feasts with relatives and friends happen almost all the time.

Preparing food together on a large board will allow you to enjoy every moment spent together.





Warmth at your fingertips

MASURIA®



Stilo 600, Stilo 800

Functionality and ecology

With its wood storage area, **Stilo** is a functional hearth that provides plenty of natural heat and allows you to cook exceptionally tasty dishes in nature.

The wood in the dedicated storage area complements its raw design style wonderfully.

Stilo has an ergonomic wood-burning hearth that makes maximum use of its calorific value with minimum consumption. The special board allows you to create a healthier and much more comfortable alternative to the traditional barbecue.

Airflow adjustment in the **Stilo 600** version allows you to easily adjust the temperature of the board to your needs, while the **Stilo 800** version, due to its size, has an optimised airflow system that does not require adjustment.

The proprietary hearth cleaning system provides an additional advantage, quickly and conveniently allowing you to prepare the hearth for reuse.

Simple, timeless form available in two colour versions will work well in most arrangements as a functional decoration.



Stilo 600



MASURIA®

Additional information

Weight 50 kg
Dimensions 59 × 59 × 99 cm

Colours



Corten



Black

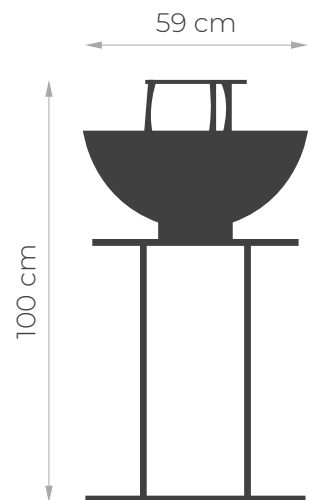

Stilo 800



Additional information

Weight 142 kg

Dimensions 84 × 84 × 105 cm

Colours



Corten



Black

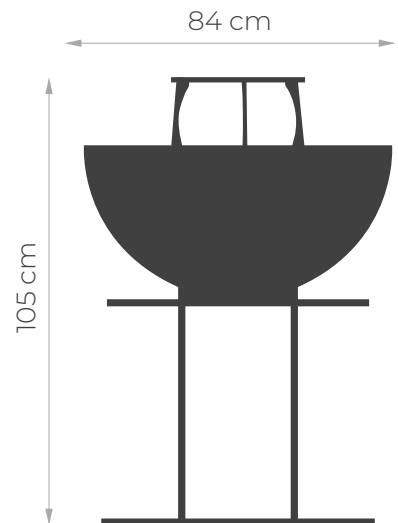



Grill extension

With an additional accessory such as an extension, you will increase the possibilities of cooking tasty meals in the traditional way.

Plancha

Made of thick steel, the sturdy and even board allows you to cook perfect meals safely and healthily.

It is designed to maintain a constant temperature over its entire surface, allowing you to cook multiple dishes at once.





Air adjustment

Adjustment of air flow is possible thanks to precisely designed and manufactured openings and a proprietary mechanism.

Space for kitchen accessories

A practical place to put away the necessary kitchen accessories for preparing baked foods. Tongs or a spatula are always close at hand.

The stainless steel finish ensures that it is easy to keep clean.





Stable base

Functionality and safety constitute the basis for using MASURIA products.

Thanks to the use of a stable base which is useful in its form, **Stilo** gives us a guarantee of safety and the possibility of storing wood, so that it is always at hand.

Space for wood

The use of a dedicated wood storage area not only adds visual appeal, but more importantly ensures that wood is always within reach, making **Stilo** a very practical and versatile hearth.



Stilo 600 and **800** hearths were developed with the most demanding user in mind, for those who appreciate the unlimited possibilities enclosed in a perfectly tailored form.

Stilo are hearths designed for private gardens, where the love of good food is combined with the joy of spending time together, and for restaurants that would like to surprise their guests with unique experiences.



ACCESSORIES

Cooking requires an inspiring setting and accessories that will allow you to enjoy every dish prepared with passion. It has long been known that accessories or kitchen utensils are as important as using quality products.

Picturesque scenery, the smell of freshly tanned wood, the air scented with nature - all this makes us treat cooking outside as something unusual, requiring a special approach. The presented accessories complete this unique atmosphere and stylise the cook as a Master Chef.





Apron

We love nature and anything directly associated with it. To provide the ultimate comfort for our fireplaces, ovens and hearths, we have designed an **apron** that not only serves a protective function, but also adds style and elegance to any chef.

Handcrafted from the highest quality, carefully-selected natural leather with high elasticity, the **apron** does not restrict movement, and allows you to cook your favourite dishes comfortably and safely.

The adjustable neck and waist straps allow you to fit it to any physique and freely indulge in culinary frenzy.



Additional information

Weight 0,5 kg

Dimensions 60 × 82 cm



Gloves

Our leather **gloves** provide excellent protection for your hands during barbecues. Natural leather, as well as Kevlar, are resistant to high temperatures and effectively protect against burns when removing hot food or baking pizza or bread in the traditional way. They will also allow you to protect your hands while operating our lamps.

The **gloves** are not only very durable, but are also distinguished by their unusual design.



Additional information

Dimensions \sqsubset 13 \times \sqsubset 35 cm



These designer **gloves** are made of the highest quality leather. Their versatility makes all activities a pleasure.

They delight with their original design and comfort of use.

Their unique form will meet the expectations of even the most demanding customers

Spatula

The **spatula** is made of high quality stainless steel and exotic wood.

The multifunctional **spatula** will find many uses in everyday life.



Additional information

Dimensions \sphericalangle 13 \times \sphericalangle 25 cm

** It is possible to prepare a complete individual cutlery set.
Please send us a message.
We will send you more information.*

Essential for cleaning the board of the hearth, the MASURIA **spatula** is made of exotic wood and stainless steel, and designed in such a way that it can also be used when cooking steaks, burgers or other delicious dishes.



Pizza shovel

The **pizza shovel** is made of stainless steel and exotic wood.

Complementary MASURIA cutlery and utensil collection, the pizza shovel will turn every user into an Italian pizza cook.



Additional information

Dimensions L 34 × L 68 cm

** It is possible to prepare a complete individual cutlery set.
Please send us a message.
We will send you more information.*

The unique **pizza shovel** is an accessory whose function corresponds with aesthetics and attention to detail. It remains in symbiosis with nature. It also ensures safe use. You will enjoy owning and using it.

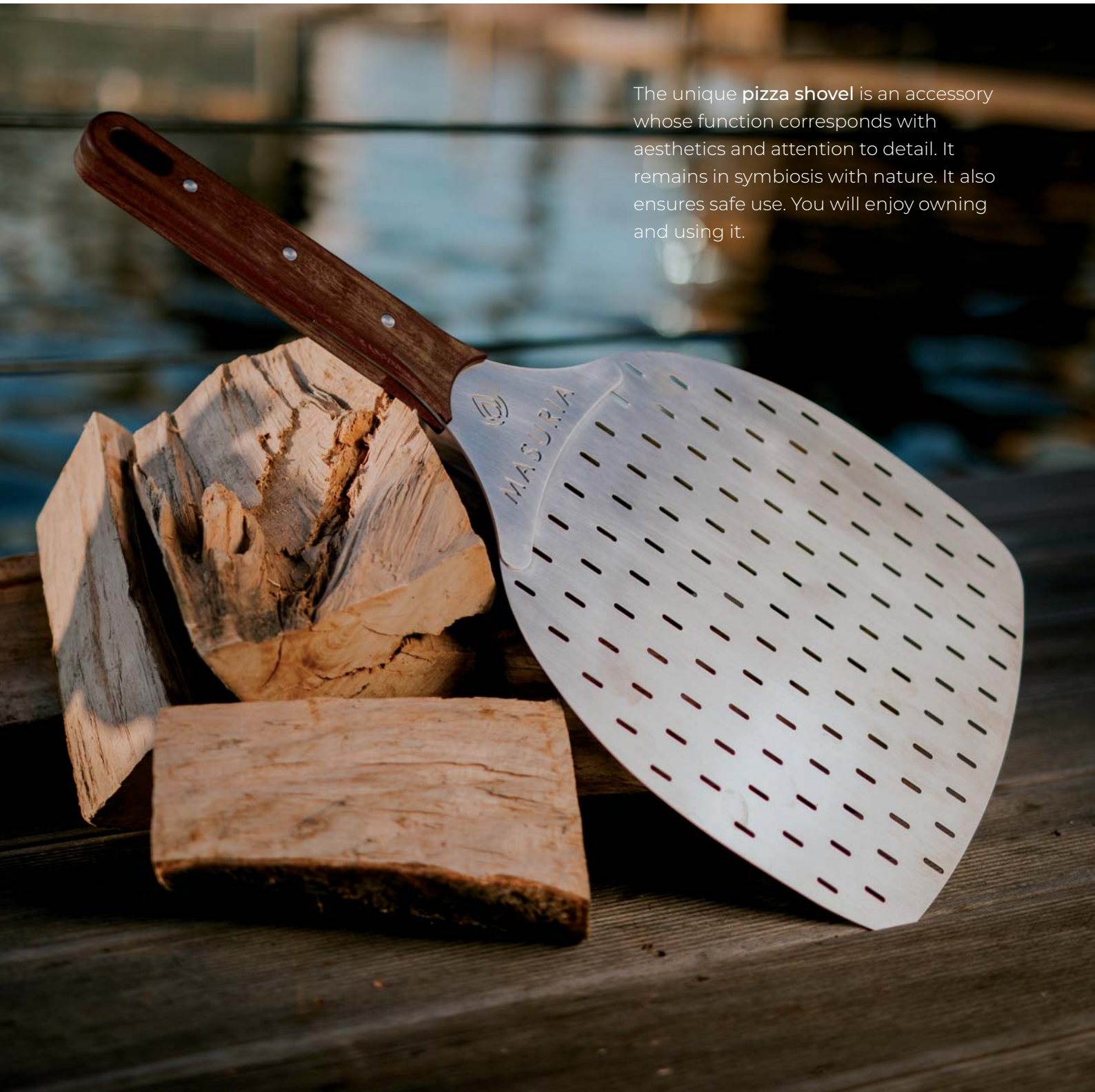

Slotted Spatula

The combination of high quality stainless steel and durable exotic wood means that the **slotted spatula** will be durable, allowing you to use it for a long time.

The **slotted spatula** provides you with the ability to cook food comfortably without worrying about getting burned. The holes in it are responsible for draining excess fat from the food. The flat, slightly rounded end is perfect for flipping any type of food.

MASURIA®

Additional information

Dimensions 29 × 15 cm

** It is possible to prepare a complete individual cutlery set.
Please send us a message.
We will send you more information.*





The MASURIA slotted spatula means safe, comfortable and healthy barbecues, combined with long-lasting use and exceptional aesthetics.

Knife

The **knife** from our collection will be perfect for cutting previously prepared dishes. Thanks to the specially-shaped handle, the knife ensures safe use.

The **knife** is made of stainless steel and exotic wood, which translates directly to its durability.



Additional information

Dimensions L 4 × L 50 cm

** It is possible to prepare a complete individual cutlery set.
Please send us a message.
We will send you more information.*



MASURIA knife is not just
a knife, it is THE Knife!!!

Tongs

Tongs are the most versatile tool used when grilling. With these, you can turn over any piece of meat, sausage, or vegetable. No wonder they are used so often, not only when grilling, but also in the kitchen when frying or baking.

Made from high quality stainless steel, as well as exotic wood, they provide durability for years to come.

An appropriate length of handle prevents burns and ensures freedom when manoeuvring. The small serrations at the end provide a better grip on your food, thanks to which you can place it precisely on your plate.



Additional information

Dimensions L 9 × L 50 cm

** It is possible to prepare a complete individual cutlery set.
Please send us a message.
We will send you more information.*

Cooking, grilling, baking at the highest level for all customers can only be provided by MASURIA tongs.



Fork

The **fork** is made of durable materials: high quality stainless steel and exotic wood. Its size is large enough to allow users to cook food safely and comfortably without fear of getting burned. Stainless steel is a guarantee of quality - the **fork** will be durable, allowing you to use it for a long time.

MASURIA®



Additional information

Dimensions 4 × 50 cm

** It is possible to prepare a complete individual cutlery set.
Please send us a message.
We will send you more information.*



The shape and design of the fork result from caring about comfort of use and an aesthetic customer experience, as provided by MASURIA.

Set - fork and knife

This barbecue cutlery **set** is made of high quality stainless steel and exotic wood. It is essential for cooking safely outdoors. The set includes: **fork and knife**. Each piece is about 50 cm long, which ensures secure and reliable handling without the risk of burns.



Additional information

Dimensions \sphericalangle 4 × \sphericalangle 50 cm

** It is possible to prepare a complete individual cutlery set.
Please send us a message.
We will send you more information.*





MASURIA®

masurialiving.com